

Tragarm-System

profiPLUS 50

Type:

Winkelkupplung, hängend

Artikel-Nr.:

142.035.000

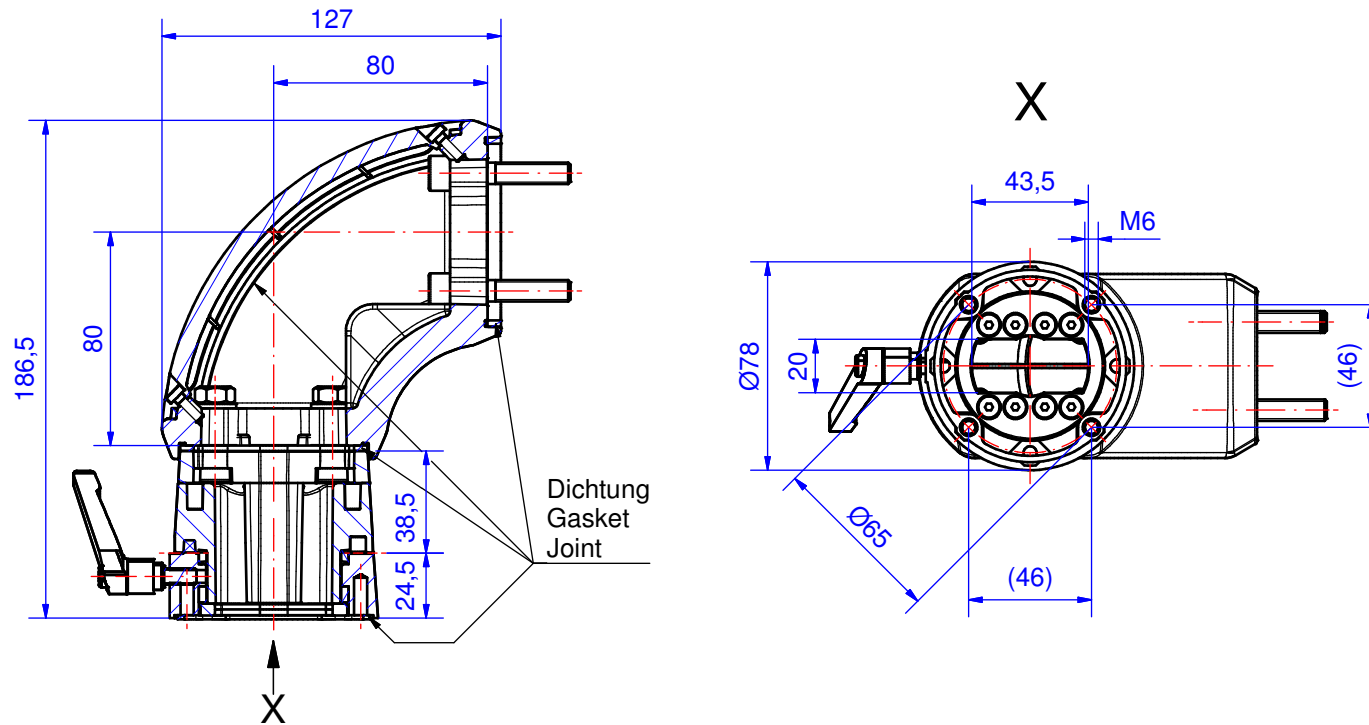

Material Systemelemente	GD-AI Si 12 (DIN 1706)		Schwenkbereich	310°
Dichtung	4x Zellkautschuk (CR), schwarz		Gewicht	1.260 g
Montageschrauben	4x M8, 4x M6, Stahl verzinkt		Beschichtung	Pulverlackierung RAL 7035, lichtgrau
Schutzart	IP54 EN 60529		Toleranz	Außenmaße ±0,8mm, Restmaße nach GTA 13/5 DIN 1688-4