

# Tragarm-System profiPLUS 70

Type: Aufsatzgelenk

Artikel-Nr.: 143.005.000

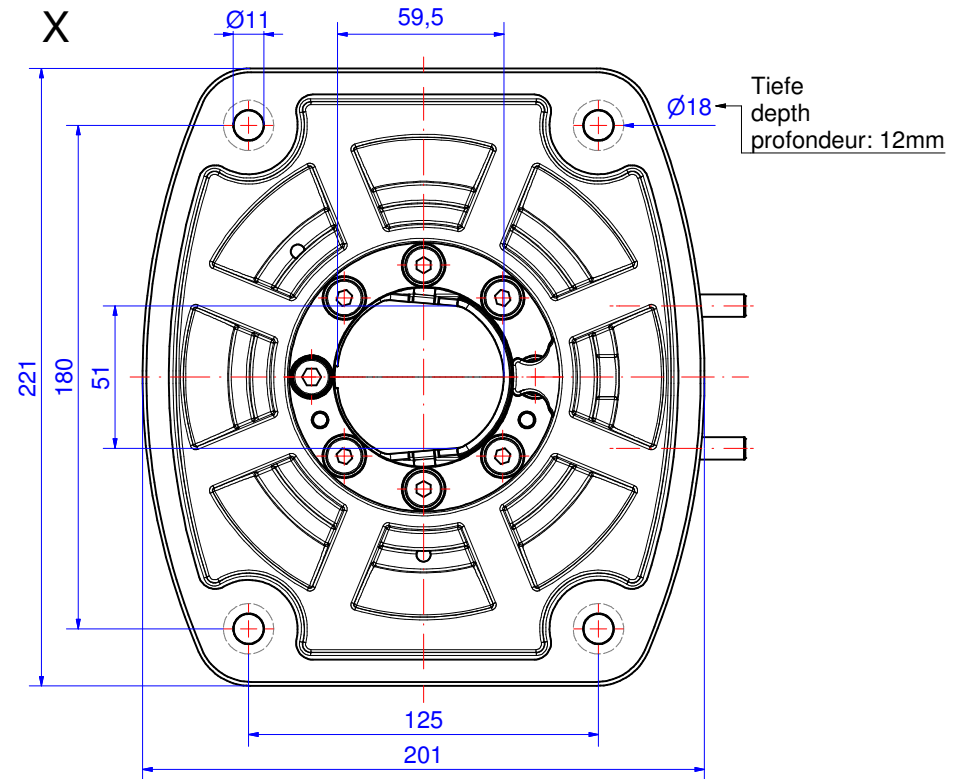
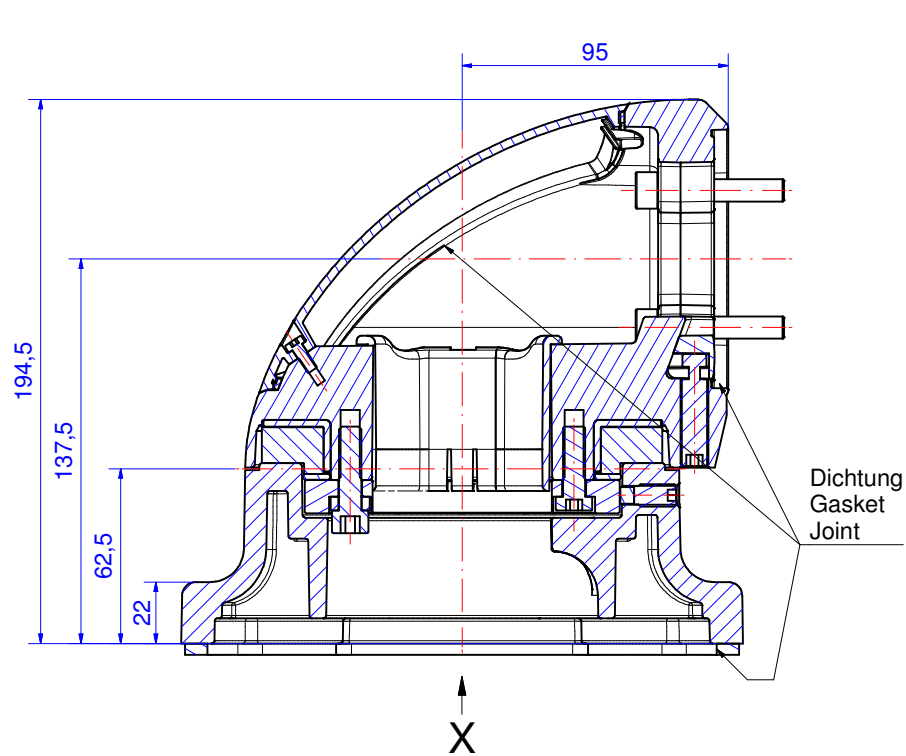

Material Systemelemente	GD-Al Si 12 (DIN 1706)		Schwenkbereich	304°
Dichtung	3x Zellkautschuk (CR), schwarz		Gewicht	5.380 g
Montageschrauben	4x M8, Stahl verzinkt		Beschichtung	Pulverlackierung RAL 7035, lichtgrau
Schutzart	IP54 EN 60529		Toleranz	Außenmaße ±0,8mm, Restmaße nach GTA 13/5 DIN 1688-4